

PLEASE READ AND UNDERSTAND ALL SECTIONS IN THIS MANUAL BEFORE YOU BEGIN YOUR INSTALLATION.

For additional information please visit inhausurfaces.com or call 1.888.255.3412.



WARNING! DO NOT SAND, DRY SWEEP, DRY SCRAPE, DRILL, SAW, BEADBLAST OR MECHANICALLY CHIP OR PULVERIZE EXISTING RESILIENT FLOORING, BACKING, LINING FELT, ASPHALTIC “CUTBACK” ADHESIVES OR OTHER ADHESIVES.

These products may contain asbestos fibers and/or crystalline silica. Avoid creating dust. Inhalation of such dust is a cancer and respiratory tract hazard. Smoking by individuals exposed to asbestos fibers greatly increases the risk of serious bodily harm. Unless positively certain that the product to be removed is a non-asbestos containing material, you must presume it contains asbestos. Regulations may require that the material be tested to determine asbestos content. See current edition of the Resilient Floor Covering Institute (RFCI) publication, “Recommended Work Practices for Removal of Resilient Floor Coverings” for detailed information and instructions on removing all resilient covering structures. For current information, go to www.rfci.com.

WARNING:

Drilling, sawing, sanding or machining wood products can expose you to wood dust, a substance known to the State of California to cause cancer. Avoid inhaling wood dust or use a dust mask or other safeguards for personal protection. For more information go to www.P65Warnings.ca.gov/wood.

CAUTION:

- Use a dust mask, safety glasses and gloves when cutting Lamdura flooring.
- If using power tools to cut planks, always cut in a well-ventilated area.
- Never use tools designed for other flooring installation systems (eg. seam rollers, tap blocks, etc.).
- Never wax, polish or use abrasive cleaners on Lamdura floors as they may damage the floor’s finish beyond repair.
- This product is a floating floor. It should not be nailed/screwed to subfloor or in anyway pinned to the subfloor by the installation of furniture or cabinets.

NOTE: If excessive moisture accumulates in buildings or on building materials, mold and/or mildew growth can occur. Care should be taken to address any moisture related issues prior to installing Lamdura.

INTENDED USE

Lamdura floors are intended for indoor use only and can be installed in any room as long as it does not have in-floor drainage. All Lamdura floors have been designed to withstand the requirements of the busiest households as well as limited commercial applications. Prior to installing Lamdura floors, please refer to the Lamdura Approved Placement document and read the warranty documentation specific to your application to determine its suitability.

HANDLING

- Handle Lamdura with care prior to installation; protect carton edges, do not drop cartons, etc.
- Always store Lamdura cartons flat and properly supported on a level surface.
- Never lean cartons against walls and do not store them on saw-horses or similar equipment that does not fully support the full length of the cartons.

LAMDURA PLUS PAD LAMINATE FLOORING INSTALLATION INSTRUCTIONS

PRE-INSTALLATION

Prior to installing, check all planks for color against samples used in selection to ensure correct product. Further, inspect for defects and transportation damage. Any planks that show damage or defects should not be used.

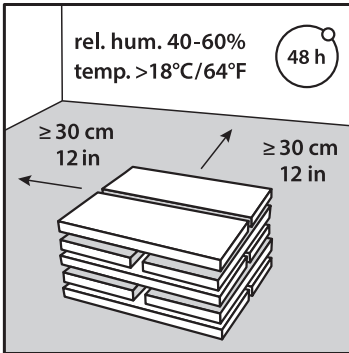

ACCLIMATION

Best practices require 48 hours to acclimate Lamdura to the conditions of the installation area.
To acclimate: cross-stack unopened cartons in the installation area and at room temperature approx. 64°F-73°F (18°C-23°C).

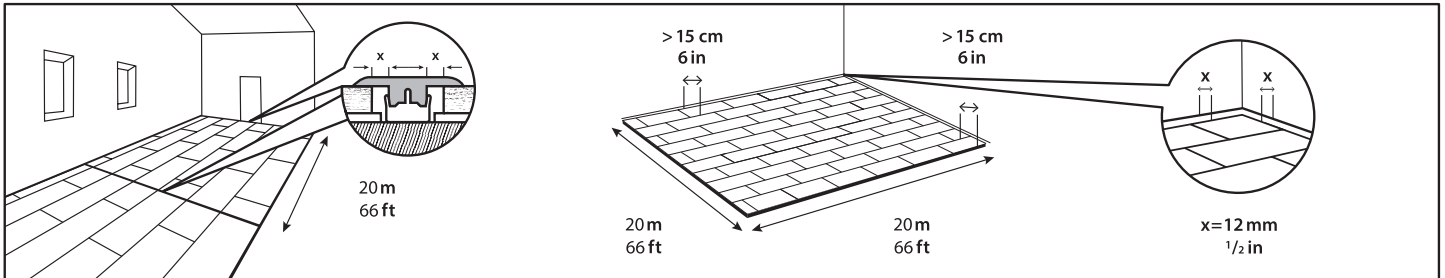

EXPANSION SPACE

For installations up to 40' in length or width, it is necessary to leave a 3/8" (10mm) expansion space around the perimeter of the room and all other objects (e.g. toe kicks, plumbing, etc.). For longer installations up to 66', a 1/2" (12mm) expansion gap will be required. The expansion space will be covered by the wall base or quarter round once the floor is installed. *If installing in moisture prone areas, please refer to the Recommendations for Wet Area Installation section of this guide.*

TRANSITIONS

It is recommended that transitions (T-Moldings) be used to separate rooms. If using transitions, ensure the necessary expansion space is left between Lamdura planks and the vertical section of the T-Molding.

MAXIMUM ROOM SIZE

Lamdura floors can be installed in a single room up to 4,000 ft² (372 m²) and/or 66 linear feet (20 m) in length or width. Installations in rooms that are over 66 linear feet (20 m) in length and overlaps to adjacent rooms should use expansion joints to divide the floor sections.

INSTALLATION LAYOUT

There are no rules when it comes to the direction you choose to lay planks in your installation. Typically, Lamdura flooring installations are oriented in the following manner: Parallel to the longest wall in the room, or perpendicular to the main window in the room.

PRE-INSTALLATION CONTINUED

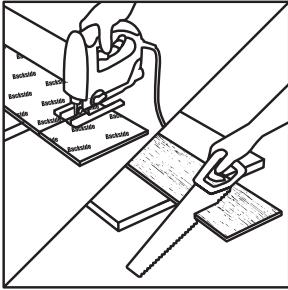

CUTTING PLANKS

Lamdura flooring planks are designed to be cut with guillotine-type flooring cutters and power saws (e.g. circular saw, table saw, miter saw, jigsaw) as well as hand saws. It is important to use good quality, sharp blades in order to minimize damage to the planks; however, small chips along the cuts will be hidden by the wall base or trim.

NOTE: Lamdura planks should always be cut away from the installation area in order to minimize debris and dust in the installation site. Always wear protective equipment such as safety glasses, a NIOSH-approved dust mask and gloves.

TOOLS AND MATERIALS REQUIRED

- Measuring tape
- Pencil or marker
- Utility knife
- Pull bar
- 2" (51 mm) wide moisture resistant adhesive tape
- Handsaw or door jamb saw
- Saw (any of the following):
 - Guillotine-type cutter
 - Miter saw
 - Table saw
 - Circular saw
 - Jigsaw
- 3/8" (10 mm) spacers
- Safety glasses & dust mask (NIOSH designated)
- Appropriate glue if installing in areas where planks cannot be angled (e.g. under door jambs)
- 100% flexible neutral curing silicone caulking if installing in moisture prone areas
- PE backer rod if installing in moisture prone areas

SUBFLOOR PREPARATION

Lamdura floors can be installed over many types of subfloors as long as they are properly prepared and meet the required criteria outlined below.

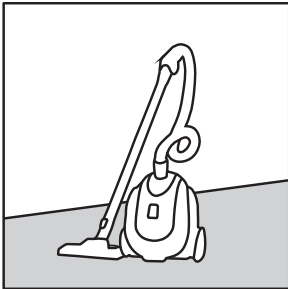

GENERAL SUBFLOOR PREPARATIONS & PRECAUTIONS

- Subfloors must be clean and free of dirt and debris prior to installation.
- Subfloors must be structurally sound.
- Lamdura floors can be installed in bathrooms, kitchens, and entryways by following the *Recommendations for Wet Area Installations* section of this guide.
- Variations in the subfloor flatness should not exceed 5/64" per 3 ft (2mm per m) or 3/16" in 10 ft (5 mm in 3 m). Floors must be leveled to meet this specification prior to installation. Level by filling depressed areas with floor leveling compounds and grinding down any raised areas.
- Abrupt height differences of more than 3/64" per 4 in. (1mm per 10cm) must be corrected (for example, nail heads, concrete ridges and other similar small protrusions).
- All carpet, carpet pad and carpet tack must be removed prior to installation.
- Care must be taken to ensure that the subfloor meets all local building codes and regulations. If installation is below grade or on grade, foundation walls must meet all local building codes and regulations.
- Crawl spaces must meet all local building codes and regulations. Any moisture or risk of moisture existing in your crawl space should be mitigated prior to installing Lamdura.

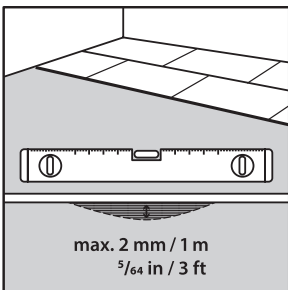

*equivalent to 1/8" in 6 ft or 3/16" in 10 ft

SUBFLOOR PREPARATION CONTINUED

CONCRETE SUBFLOORS

Concrete subfloors must be properly cured and allowed to dry for at least 60 days prior to installation of Lamdura.

Always test concrete subfloor for moisture prior to installation. To do so:

- Tape 3' x 3' (91cm x 91cm) pieces of polyethylene vapor barrier to subfloor.
- If condensation appears on the film after 24 hours or concrete appears dark in color, moisture is likely present, and a Calcium Chloride test must be performed.

The maximum allowable moisture emission is 5.0 lbs./1000 ft² per 24 hours (2.26 kg/100 m² per 24 hours) ASTM F1869. Alternatively, a Tramex test can be performed in accordance with ASTM F2659. However, recorded values higher than 4.5% require a Calcium Chloride test to verify that the subfloor moisture is appropriate. In Situ probe testing can also be used according to ASTM F2170 and the reading should not exceed 75%.

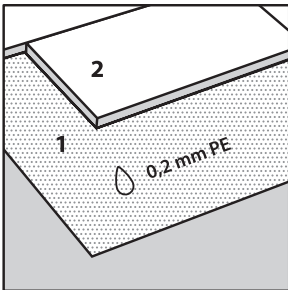

- A minimum 6 mil (0.2mm) polyethylene vapor barrier must be used when installing over concrete.
- Overlap vapor barrier edges by 8" (20cm) and seal with moisture resistant adhesive tape.
- Run vapor barrier 3/4" (2cm) up wall and install wall base trim over it.

WOOD SUBFLOORS

- Wood subfloors must be structurally sound and screwed or nailed to supporting beams.
- Subfloor moisture must be tested prior to installation and should not exceed 12% throughout the installation area.
- Do not install Lamdura floors over wood subfloors applied directly to concrete.
- Crawl space should be dry and vented as per local building code.

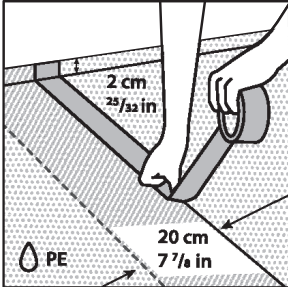

VINYL (SHEET/TILE), LINOLEUM, CERAMIC TILE

- Existing floor covering must be in good condition with no tears, cracks or chips.
- Floor covering should be well bonded to the subfloor and the surface should be flat and smooth.
- Heavily cushioned floor covering (eg. cushion vinyl) and resilient floors that exceed one layer in thickness should be removed. Follow manufacturer's guidelines when uninstalling resilient floor coverings. Wear personal protection

equipment (dust mask, gloves, glasses, etc.).

- If installing over ceramic tile, any abrupt unevenness of more than 3/64" per 4 in. (1mm per 10cm) must be corrected.
- If vinyl, linoleum, or ceramic tile is installed over concrete, a 6 mil (0.2mm) vapor barrier must be installed over it.
- Overlap vapor barrier edges by 8" (20cm) and seal with moisture resistant adhesive tape.
- Run vapor barrier 3/4" (2cm) up wall and install wall base trim over it.

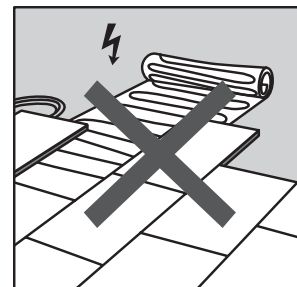
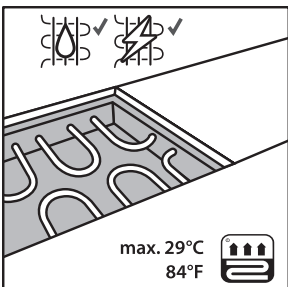

INSTALLATIONS OVER RADIANT HEATING SYSTEMS

Lamdura flooring can be installed over embedded in-floor heating systems and must have a minimum of 1/2 in. (12mm) separation from the product. Maximum temperature should never exceed 84° F (29° C).

- In-floor heat systems must be operating for a minimum of 3 weeks prior to installation of Lamdura floors.
- Floor heating systems should be applied to the entire area of the installation or separated by transitional moldings.

ROOM PREPARATION

WALL BASE /TRIM

- Removal of existing wall base/trim is optional. If you decide not to remove your wall base then, you will have to install quarter-round moldings after installation of your Lamdura floor is complete.
- Wall base or trim will need to be installed once the flooring installation is complete to cover the expansion space around the perimeter of the room.
- Always nail/adhere wall base and trim to the wall. Never nail/adhere it to the flooring.

WALL IRREGULARITIES

Walls are not always perfectly straight. Lamdura floors will need to be cut so as to fit within irregularities of your walls. To do so:

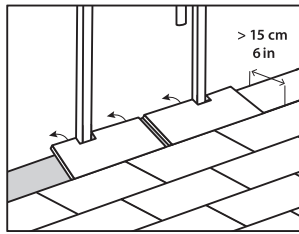
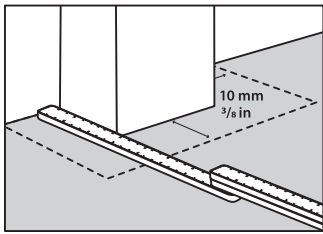

1. Install a complete first row of Lamdura floors (following the Installation Procedures below) and ensure that all long edges of the Lamdura flooring are aligned flush with one another.
2. Slide the whole row against the wall; you will now notice any wall irregularities (i.e. areas where the wall is not straight).
3. Trace the contour of the wall onto the row of Lamdura

flooring with a pencil or marker. Once traced, uninstall the planks carefully so as to not damage the locking system and cut along the traced line (see Plank Removal section below).

4. Re-install the planks leaving the necessary expansion space between them and your wall.

CABINETS & ISLANDS

- It is best practice to install cabinets prior to installing Lamdura floors.
- If cabinets need to be installed after Lamdura is installed they should be mounted to the wall and in a manner that does not pin Lamdura and prevent it from performing as a floating floor.
- Permanent/fixed islands should always be installed prior to installing Lamdura.
- Free-standing kitchen islands can be placed on top of Lamdura floors provided:
 1. They do not exceed 500 lbs (227 kg).
 2. They are not fastened to or through Lamdura.
 3. They do not prevent Lamdura floors from expanding and contracting.
 4. They are not equipped with gas lines or plumbing.

DOORS & DOOR JAMBS

Lamdura floors should be installed under door jambs. As such door jambs will need to be undercut accordingly. To do so:

- Use a Lamdura flooring off-cut to support your saw blade at the correct height for undercutting.
- Check door clearances and make any necessary height adjustments before installing Lamdura floors.
- Make sure to leave the the necessary expansion spacing from the wall under the door jamb.

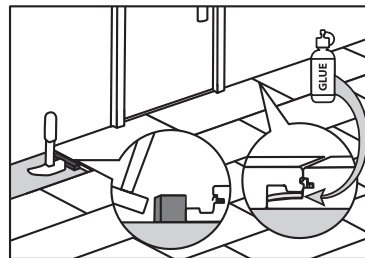
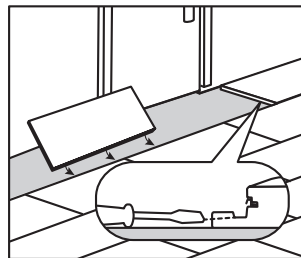
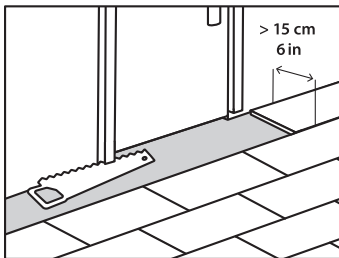

TIP: If possible, it is often easiest to start the flooring installation the door of the room so that the first plank can be easily slid under the door jamb.

- In some cases, you may have to modify a plank's locking system as a door jamb may prevent you from angling it into place. To do so, safely remove the vertical section of the groove. This will allow you to slide planks together horizontally. Apply a small amount of adhesive into the plank's groove and slide the plank into place.

INSTALLATION PROCEDURE

- It is recommended that planks be mixed from at least three cartons to achieve the most natural and varied appearance. There are many unique planks in every Lamdura design. However, during production, the same plank may be inserted into one carton multiple times. It is important to mix planks from multiple cartons and review the installation often to ensure the most random appearance.
- Inspect every plank for damage and visual defects before installing it. DO NOT INSTALL damaged or defective planks.
- Never force planks together using excessive force. If planks are not fitting together easily check joint alignment and inspect for debris in the joints.
- The first and last row of the installation should be wider than 4" (10cm). To ensure this will be the case, prior to installation:
 1. Measure the width of the room and divide it by the width of the planks you are installing.
 2. If the remainder is less than 3.5" (9cm) cut 3.5" (9cm) from the width of the first row. If this is not possible, simply ensure that both edge planks are as even in width as possible.
- The first and last plank in a row should be a minimum of 12" (30cm) long.
- Stagger the planks from row to row by a minimum of 12" (30cm).
- Stand up and walk around the installation every 100 sf to inspect for color and gloss variations, defects, and similar (duplicate) planks adjacent to each other.
- Use spacers to maintain the necessary expansion space between the first row and the wall.
- Select a starting corner of the room and work from left to right.

INSTALLING THE FIRST ROW

You can connect planks in your first rows in two ways:

Method #1:

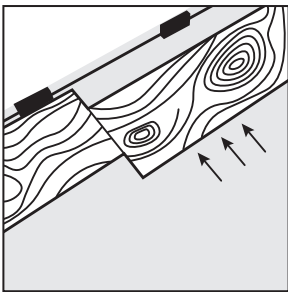

1. Lay the first plank with the long edge tongue facing the wall.
2. Lay the second plank flat on the floor and adjacent to the first plank with the short edge joint aligned with the groove of the first plank.
3. Slide the planks perpendicular to each other engaging the short edge locking system.
4. Continue in this manner until the first row is complete, cutting the last plank to complete the row.
5. Use the remainder of the last plank of the first row to start the second row provided that it is a minimum of 16" (40cm) long.

Method #2:

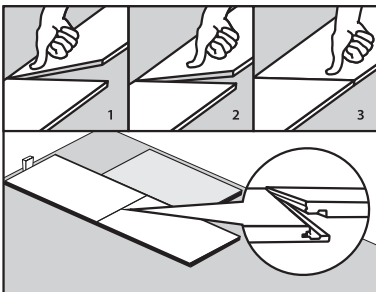

1. Lay the first plank with the long edge tongue facing the wall.
2. Lay the second plank flat on the floor with the short edge joint aligned directly over the groove of the first plank.
3. Apply downward force with thumbs to connect the two planks together.
4. Continue in this manner until the first row is complete. You will have to cut the last plank to complete the row.
5. Use the remainder of the last plank of the first row to start the second row provided that it is a minimum of 16" (40cm) long.

INSTALLATION PROCEDURE CONTINUED

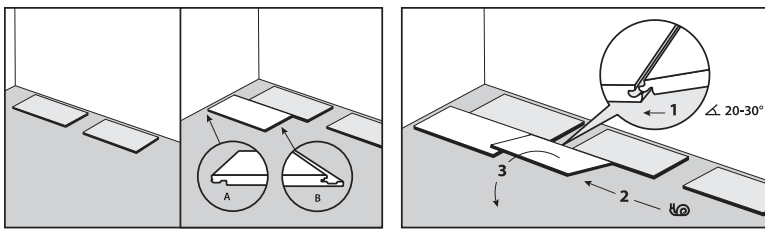

It's important that the long edges of the first row be perfectly straight and aligned in order to facilitate ease of installation of all other rows.

TIP: You can use an extra plank as an alignment tool. Once you install planks of your first row together, temporarily install an extra plank that spans both first row planks you want to align. This extra plank will automatically align the first row plank's long edges. Do this down the length of your first row. The alignment planks are removed prior to continuing with your installation.

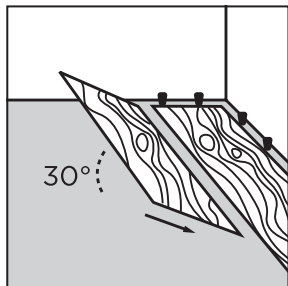
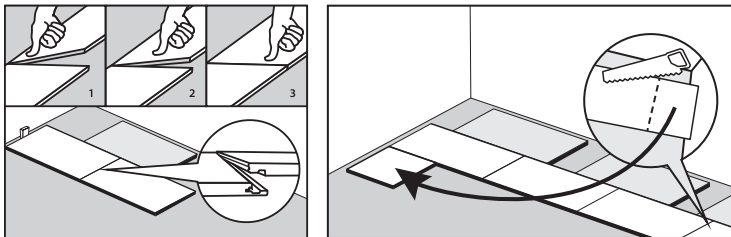

ALL OTHER ROWS

1. To install the first plank of the second row, place its long edge tongue into the previous row's long edge groove.
2. Lift the long edge groove side only to approximately a 30° angle so the edge you're holding is lifted off the floor, but the opposing long edge is resting in the previous row's groove.
3. Lower the plank to lock it into the previous row (a slight up/down, oscillating movement together with some force in the direction of the previous row may help to lower the plank).

TIP: Stand up and walk around the installation every 100 sf to inspect for color and gloss variations, defects, and similar (duplicate) planks adjacent to each other.

4. To install the remaining planks, first install the long edge of the plank you are installing to the previous row
5. Before lowering the plank, make sure its short end tongue overlaps with the previous plank's short end groove.
6. Lower the plank slowly (a short oscillating or up-and-down motion may help to seat the plank into the proper position).
7. Apply pressure to the plank's short edge starting close to the previous row and then engaging towards yourself across the width so as to activate the MegaLoc locking mechanism.
 - i. Thumb pressure should lock the plank in place but if more pressure is required, light tapping with a mallet is acceptable. Do not tap directly onto the installed planks. Place a scrap piece on top of the joint you are working on to tap on.
 - ii. Inspect every joint to ensure it is properly locked. Height differences from plank to plank at the joints is a sign of joints not being properly locked or damaged.

NOTE: Planks are designed to interlock easily and with a small amount of pressure; if this is not the case, inspect the connection system for damage or debris.

8. Continue in this manner until your installation is complete.
9. Remove all spacers.
10. Install quarter rounds, base boards and all other moldings.
11. Clean the floor and inspect it to ensure all joints are locked in place.

INSTALLATION PROCEDURE CONTINUED

PLANK REMOVAL

- To remove planks, lift the long edge of the last installed row all at once to approximately 30 degrees in order to disconnect the long edge installation mechanism.
- Once this row has been removed, disconnect each individual plank from one another by starting at the right-most plank and sliding it horizontally to disengage it from the previous plank.
- If you plan to re-install them, care should be taken so as not to damage the installation mechanism.

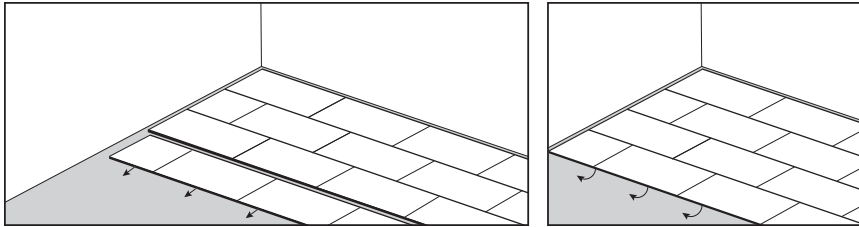

STAIR INSTALLATION

STAIR NOSING

- Stair Nosing is used on landings or stairs. Per the guidelines below, you will need to fasten laminate planks to your stair treads and risers using nails and adhesive. Please note that this applies only to the actual stair steps; flooring installed on landings or at the top of stairs should not be fastened to your subfloor.

IMPORTANT: Stair Nosing should always be installed with both nails and adhesive so as to ensure a safe and secure fit.

1. If your stair treads have existing bull-nosing, remove the bull nosing so as to have a 90-degree angle between tread and riser.
2. Using a scraper, remove the foam pad from the underside of the laminate plank.
3. If installing laminate flooring on the riser, begin at the bottom riser; measure and cut a piece of laminate flooring to fit flush with the subfloor.
NOTE: using laminate planks on stair risers is a style decision and optional. Other finishing options are acceptable.
4. Glue the piece of flooring to the riser by applying a 3" serpentine bead of construction adhesive to the back of flooring.
5. Press the plank in place.
6. Drill pilot holes on plank for 6d finishing nails and nail plank to riser.
7. Measure and cut piece of laminate flooring to width of your stair-tread (depending on the depth of your stairs you may need to use more than one piece of flooring).
8. Install the laminate flooring by gluing it to the stair-tread in the same manner as you did the riser.
9. Drill pilot holes on plank for 6d finishing nails and nail plank to tread.
10. Adhere stair nose molding to stair-tread with construction adhesive (apply 3/16" bead of adhesive in a 3" repeating serpentine pattern to the back of the stair nose).
11. Anchor stair nose molding with 6d finishing nails.
12. Always ensure you use mechanical (nail) and adhesive (glue) fasteners to secure the stair nose molding.

Stairnose molding

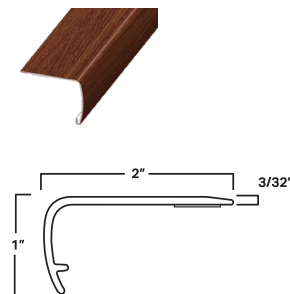

STAIRNOSE CAN BE INSTALLED IN FLUSH OR OVERLAP MANNER

FLUSH

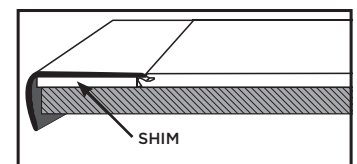

OVERLAP

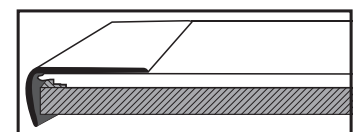

4. Glue the piece of flooring to the riser by applying a 3" serpentine bead of construction adhesive to the back of flooring.
5. Press the plank in place.
6. Drill pilot holes on plank for 6d finishing nails and nail plank to riser.
7. Measure and cut piece of laminate flooring to width of your stair-tread (depending on the depth of your stairs you may need to use more than one piece of flooring).
8. Install the laminate flooring by gluing it to the stair-tread in the same manner as you did the riser.

NOTE: If installing on a landing, or at top of stairs (i.e. not on the actual stair steps) install flooring as per the normal procedures. Do not glue laminate planks to subfloor on landings and or at top of stairs.

MOLDINGS

- Moldings can be attached with metal track (except for quarter round and stair nose), 6d finishing nails or construction adhesive (eg. Liquid Nails, PL 400). If using adhesive, apply weight to moldings while it is curing to ensure proper adhesion. Be careful not to use too much adhesive as it could penetrate the expansion space or seep onto the flooring surface.
- Never fasten moldings directly to the laminate flooring.
- Ensure that you leave at least 3/8" (10mm) expansion space between moldings, track (if applicable) and laminate floors.
- If installing over radiant heated floors, always use construction adhesive to attach moldings.
- Always pre-drill moldings with appropriate size drill bit to avoid cracking or splitting.

A. METAL TRACK

- The metal track system can be used to install T-moldings, reducers and square nose moldings. Simply screw or nail the track to the sub-floor and snap the molding in place.

B. QUARTER ROUND

- Quarter rounds are used to cover the space between the floor and existing baseboards. Nail quarter rounds to the wall, not the floor. Do not force the trim against the floor.

C. END CAP

- End Cap moldings provide a transition between laminate floors and a vertical surface such as toe-kicks and sliding glass doors. These moldings can also be used to transition between carpets and tile.

D. REDUCER

- Reducers are used to transition from laminate floors to surfaces of a lesser height such as vinyl floors.

E. T-MOLDING

- T-moldings are used in areas where the room is larger than 66' (20m) in board length or wider than 66' (20m) in board width. T-moldings should also be used where the flooring continues through a doorway or passageway into another room. T-moldings are also necessary when installing two connecting rooms where the floors are being installed in different directions.

INSTALLING MODINGS

If installing with metal track:

1. Install track first
2. Install laminate floor up to track leaving a 3/8" (10mm) expansion space between the laminate floor and the track.

If installing without metal track:

1. Measure so as to ensure that a 3/8" (10mm) space will be left between the laminate floor and the vertical part of the molding (both sides of the T-molding if applicable).
2. Install the laminate floors up to the measured point.
3. Install the molding.

MOLDINGS PROFILES

Quarter round

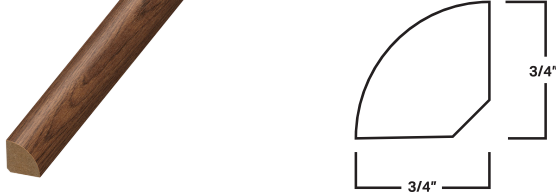

End Cap

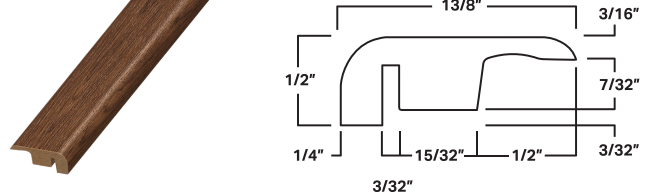

T-molding

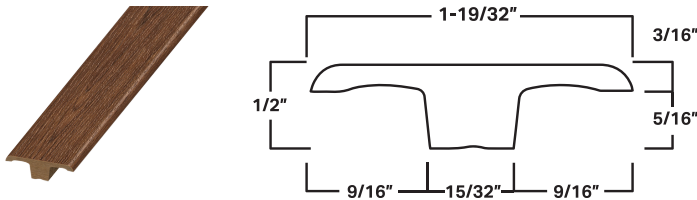

Reducer

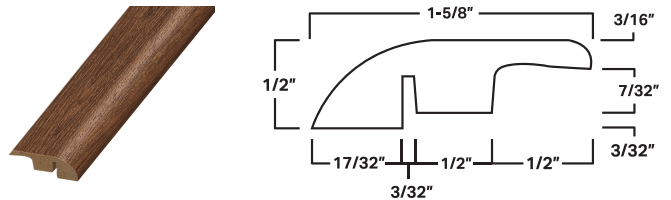

RECOMMENDATIONS FOR WET AREA INSTALLATION

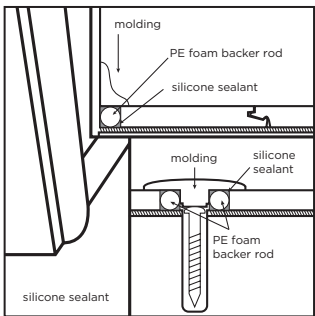

PROCEDURE:

1. Insert compressible PE foam backer rod into room perimeter expansion space and cover completely with flexible silicone caulk.
2. Insert compressible PE foam backer rod at transitions and cover completely with flexible silicone caulk.
3. Use 100% flexible neutral cure silicone caulking around door frames and other fixed objects (e.g. plumbing).
4. Install baseboards, quarter-rounds or other applicable moldings and immediately wipe up excess caulk.
5. Ensure baseboards or quarter-rounds are attached to walls, not floors.

Tip: for ease of installation use PE Foam backer with a diameter closest to the floor's overall thickness.

NOTE: PE Foam backers are suggested as a cost-effective option to minimize the excessive use of silicone.

NOTE: Do not use acrylic based caulks as they are rigid and will prevent the floor from expanding and contracting. Use only neutral curing 100% flexible silicone caulk.